

BEFORE YOU GET STARTED

You will need to make sure you have at least 2 feet of clearance of all 4 sides of your spa. We recommend the coverlift opens toward the back of the spa away from the control panel. Mounting the coverlift in any other orientation may cause interference with the spa's front access panel if any repairs or maintenance of spa is required in the future.

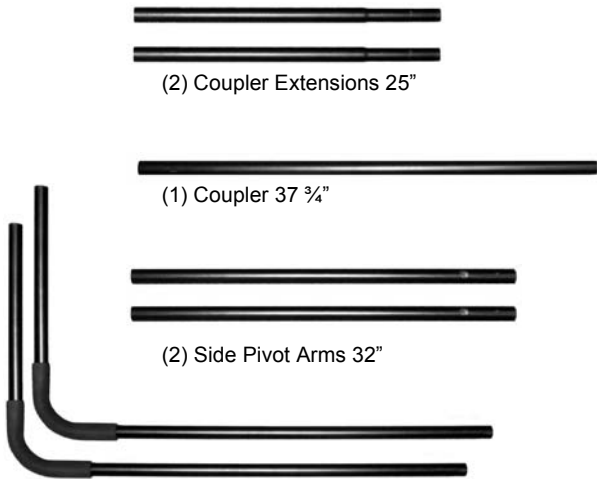

Tools required for assembly:

1. Phillips Screwdriver
2. Power drill with a 1/16" drill bit and a 1/4" drill bit.
3. Pen, Pencil or Marker
4. Wrench – 3/4"



(2) Pivot Arm Bolts 3 1/2" L



(2) Pivot Stopper Bolts
3 1/4" L, with rubber padding



JHJKHKL

(2) Mounting Brackets
NPP1011



(4) Spacer Block



(6) Washers

(4) 13/16" dia. & (2) 7/8" dia.



(18) 1" Self
Tapping Screws



(8) 1" Mounting Screws



(4) Locknuts



(4) Locknut caps



(4) Nuts



(30) Screw End Caps 7/16"

SPA COVERS UP TO 72"

(do not use coupler extension(s); position Cover Support Arms so that the long end is on the top side of the cover)

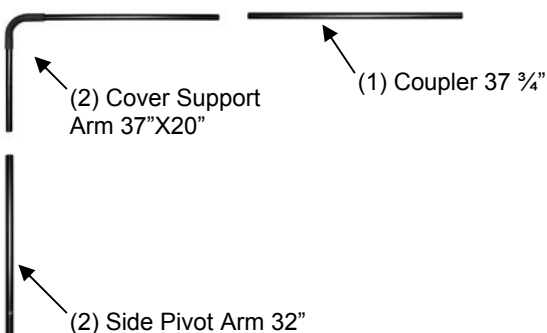

SPA COVERS 73"- 96"

(using coupler extension(s); position Cover Support Arms so that the short end is on the top side of the cover)

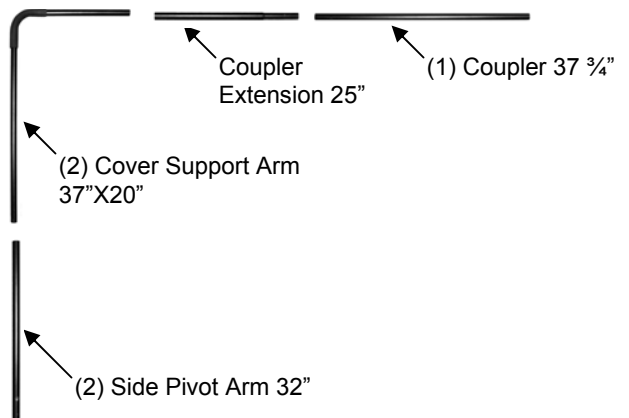

SET-UP AND ASSEMBLY:

- Place all parts in a cleared area and remove the packing materials from the spa shell; do not dispose of the packing materials until assembly is completed and the spa is in operation.
- Assembly requires two people.
- During assembly, make sure that all parts are oriented as shown in the drawings. Read each assembly step before you begin.
- Tighten all parts as you assemble them, unless instructed to do otherwise.

Step 1:

Identify Right Mounting bracket and Left Mounting Bracket. Repeat Step 2 to 5 for both right and left.



Note: Brackets must be mounted horizontally, with the angle mounted on the radius of the spa.

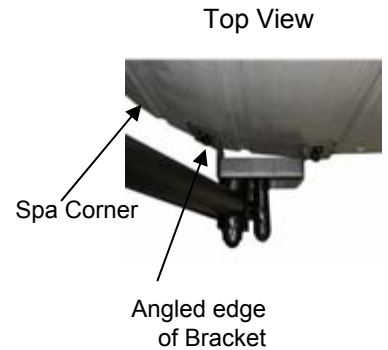
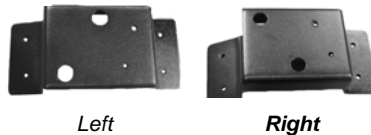
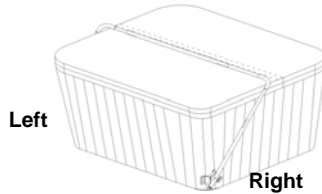

NOTE: BRACKETS CANNOT BE MOUNTED VERTICALLY

Step 2:

- Insert Pivot Arm Stopper into **center** hole of Mounting Bracket.
- Insert Pivot Arm Bolt into **side corner** of Mounting Brackets.
- Flip bracket over and put small Washer on Pivot Arm Bolt

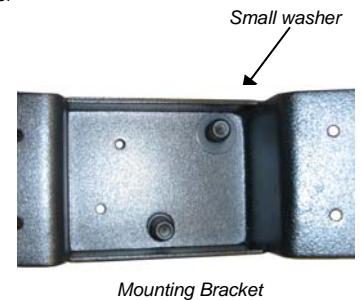
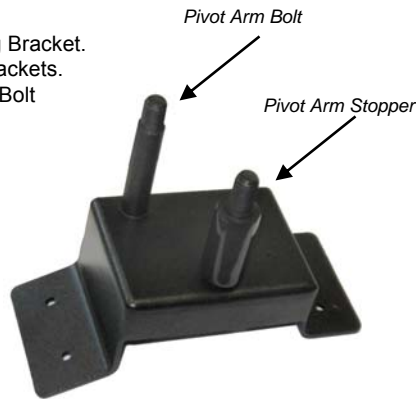
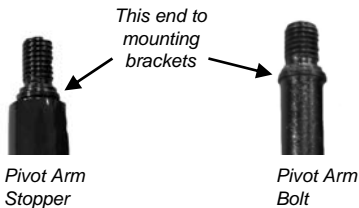

Step 3:

- With the inside of the Mounting Bracket still facing you, put Locknut on Pivot Arm Stopper.
- Put Bolt Nut on Pivot Arm Bolt.
- Secure both tightly.
- Turn bracket over and put Large Washer on Pivot Arm Bolt.

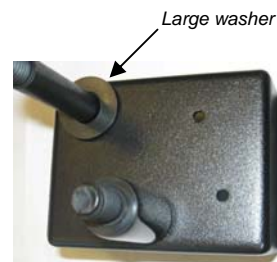
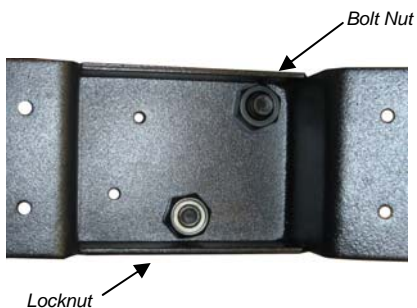

Step 4:

- Attach the left and right Mounting Brackets to the appropriate sides of the spa, 3-5" above the ground*
 - Use (4) 1" Mounting Screws for the four outer holes.
 - Use (2) 4" Mounting Screws for the two inner holes. (Fig. 4-1)

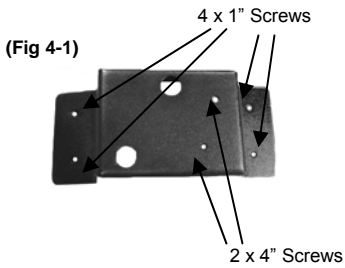

***NOTE:** To prevent splitting of the spa cabinet, pre-drill holes with a 1/4" drill bit.



Step 5:

- With bracket mounted on spa, put Spacer Block on Pivot Arm Bolt (Fig. 5-1)
- Slide on the Side Arm Pivot (Fig 5-2)
- Put outer Spacer Block on top of Side Pivot Arm on the Pivot Arm Bolt (not pictured).

Side Arm Pivot, outer Spacer Block goes on next

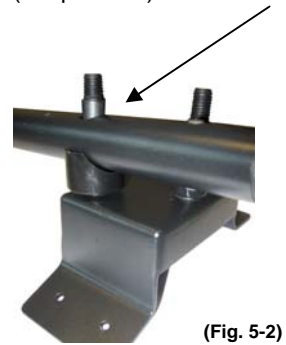
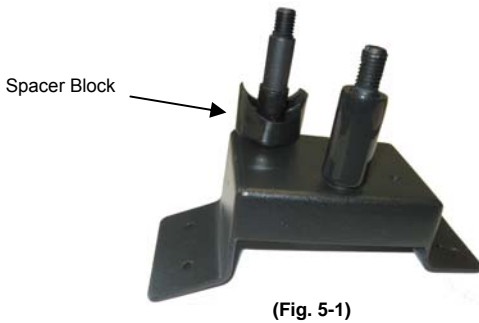

- Put a Large Washer on Pivot Arm Bolt and secure with a Locking Nut.
- Secure a Bolt Nut to Pivot Arm Stopper (Fig 5-3).
- Cover both with Nut Caps (Fig. 5-4).

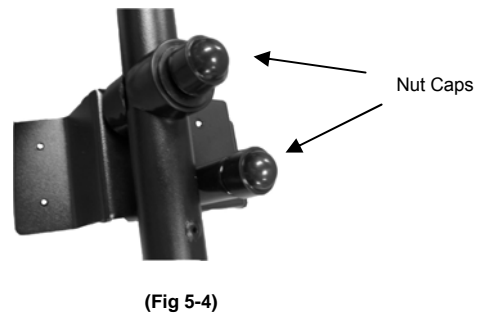
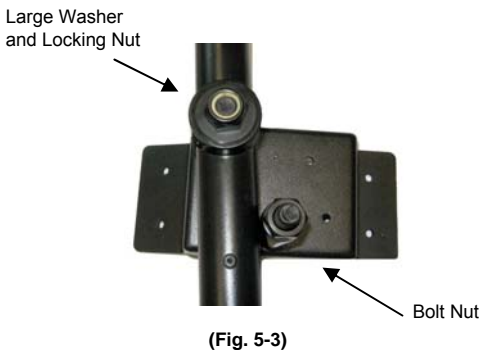

ATTENTION! SPA COVERS UP TO 72": FOLLOW STEP 6-A

SPA COVERS 73"-96": FOLLOW STEP 6-B

Step 6-A: FOR SPA COVERS UP TO 72"

- Slide the LONG END of the Cover Support Arm into either side of the Coupler piece
- Slide the SHORT END of the Cover Support Arm into the top of the Side Pivot Arm. Do the same on the other side.
- The Cover Support Arm and the Coupler will now be laying on top of the spa cover along the fold.
- THIS WILL FIT SPA COVERS UP TO 72" For larger spa covers see Step 6-B.

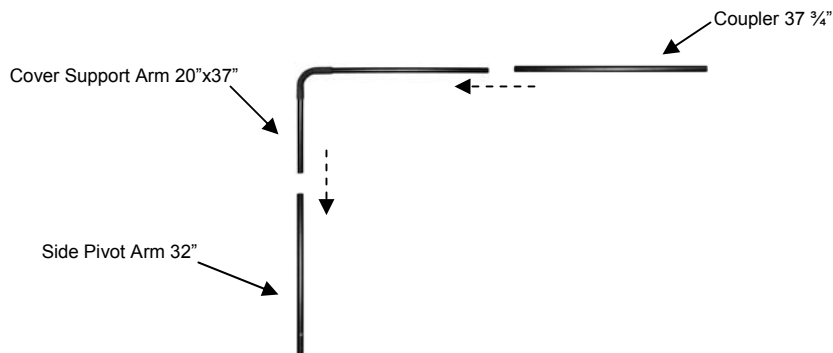

Step 6-B: FOR SPA COVERS 73" TO 96" (using Coupler Extension)

- Attach Coupler Extension Piece to one end of the Coupler and secure with 3 Self Tapping Screws.
- Slide the SHORT END of the Cover Support Arm into the Coupler Extension Piece.
- Slide the LONG END of the Cover Support Arm into the top of the Side Pivot Arm
- Secure with 3 Self-Tapping Screws. Do the same with the other side.
- The Cover Support Arm and the Coupler and the Coupler will now be laying on top of the spa cover along the fold.

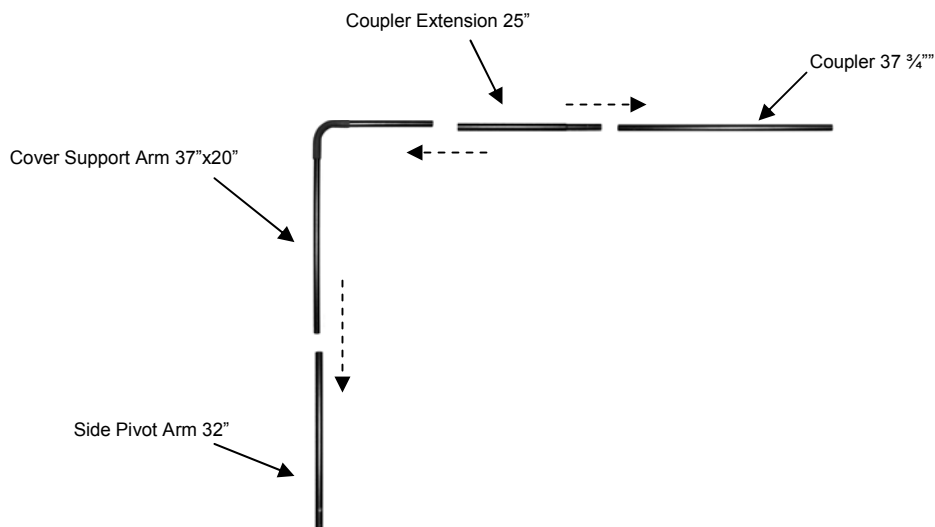

Step 7:

- Adjust the Coupler Piece and Support Arms so that the Coupler Piece is laying parallel, approximately $\frac{1}{2}$ " away from the fold in the spa cover.
- Once you have the lifter fitted to the size of your spa, pre-drill the holes that connect all the arms together.
- Using the 1" Self Tapping Screws, fasten Support Arms to the Coupler Pieces.
- There will be 3 Self Tapping Screws inserted into each end of the Coupler Pieces and 3 Self Tapping Screws inserted into each Cover Support Arm where it connects to the Side Pivot Arm.
- Place Screw Caps on top of all screws.

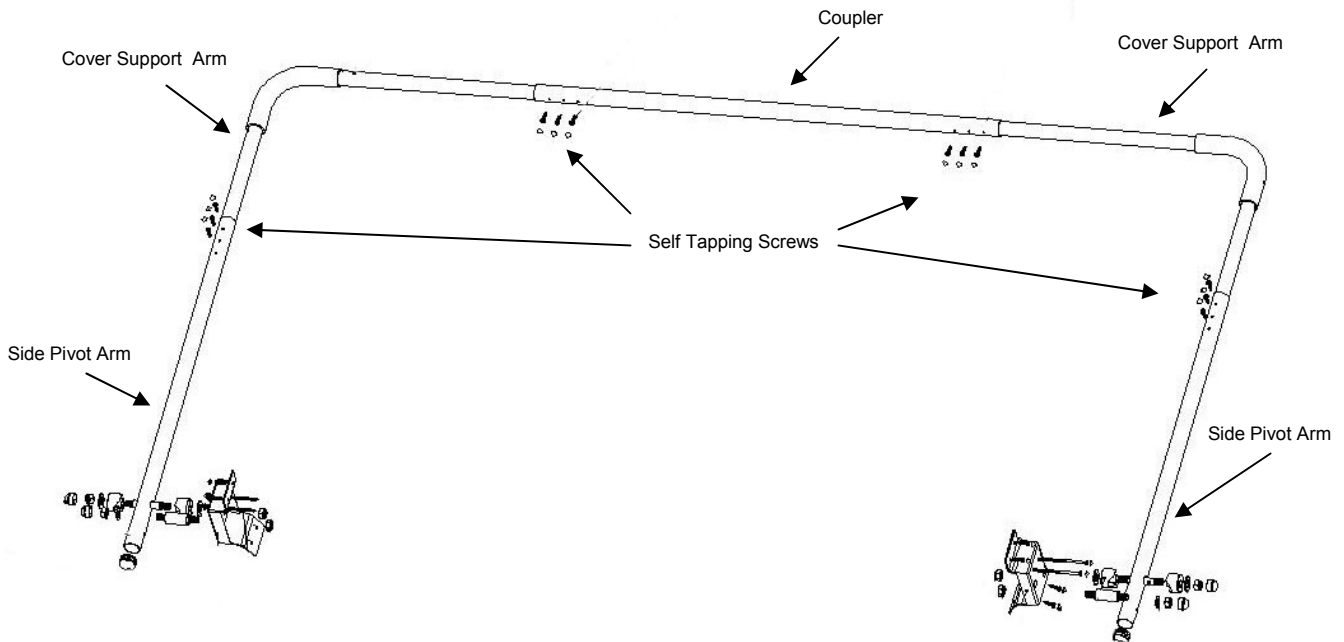

To Remove the spa cover with the Coverlift:

- Fold the Spa Cover at the hinge over the Cover Lift
- Using the Coverlift bar, lift the cover up and toward the back of the spa. The cover will slide back and down the back side of the spa and stop.

